

LAPPSET®







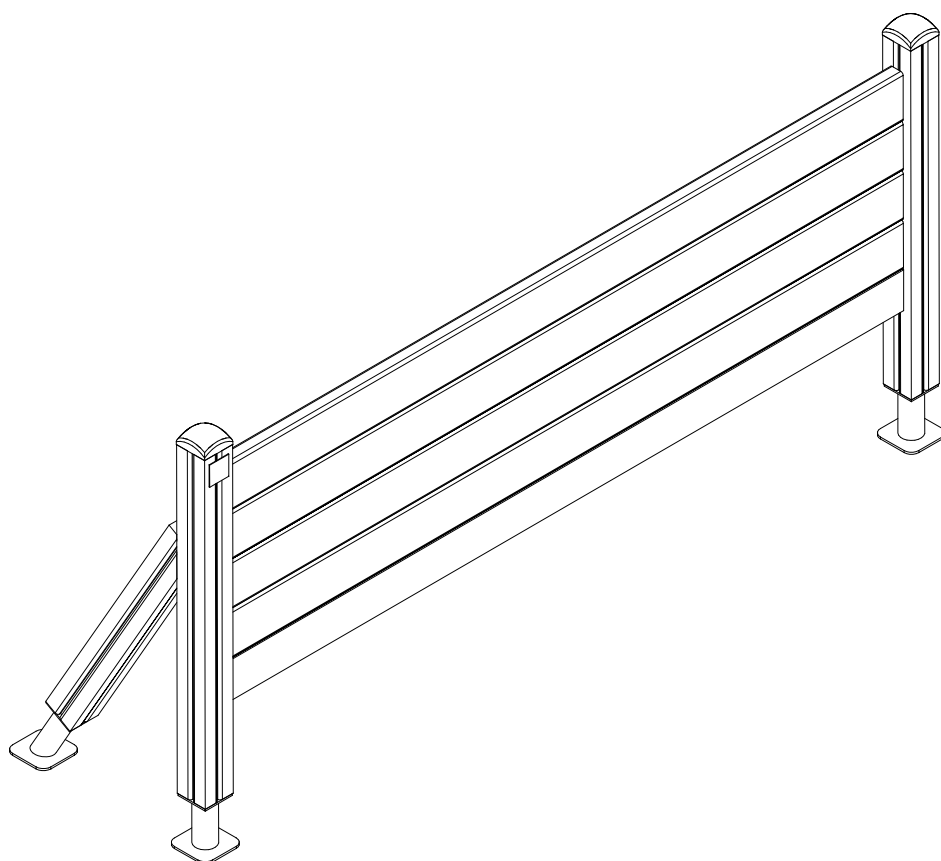

FINNO

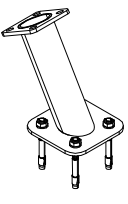
ASENNUSOHJE
MONTERINGSANSVISNING
INSTALLATION INSTRUCTION
AUFBAUANLEITUNG
NOTICE D'INSTALLATION

DATE: 22.9.2016

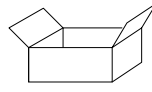
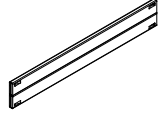
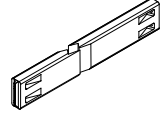
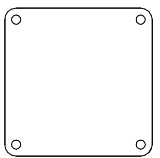
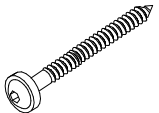
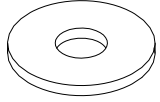
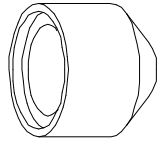
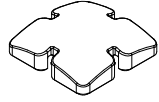
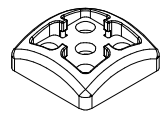
Q10835

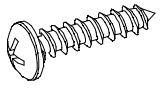
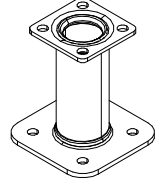
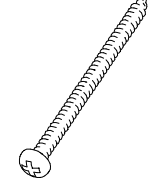

  701899 PCS 2	 702286 PCS 1 90x50	 706466 PCS 2 93x93x1025	 706551 PCS 2	 707273 PCS 2 45x290x2324	 707295 PCS 1 L 2304
 902487 PCS 1 65x65	 903093 PCS 12 Ø8x90	 905051 PCS 4 Ø25	 905104 PCS 8 M10	 905138 PCS 2 GRAY	 905196 PCS 2 GRAY
 909231 PCS 2 8x130	 909233 PCS 2 8x100	 909506 PCS 4 Ø3.5x13	 909531 PCS 2 130x130x150	 980131 PCS 8 Ø6x60	 P00109 PCS 2 L 840
PCS	PCS	PCS	PCS	PCS	PCS
PCS	PCS	PCS	PCS	PCS	PCS
PCS	PCS	PCS	PCS	PCS	PCS
PCS	PCS	PCS	PCS	PCS	PCS

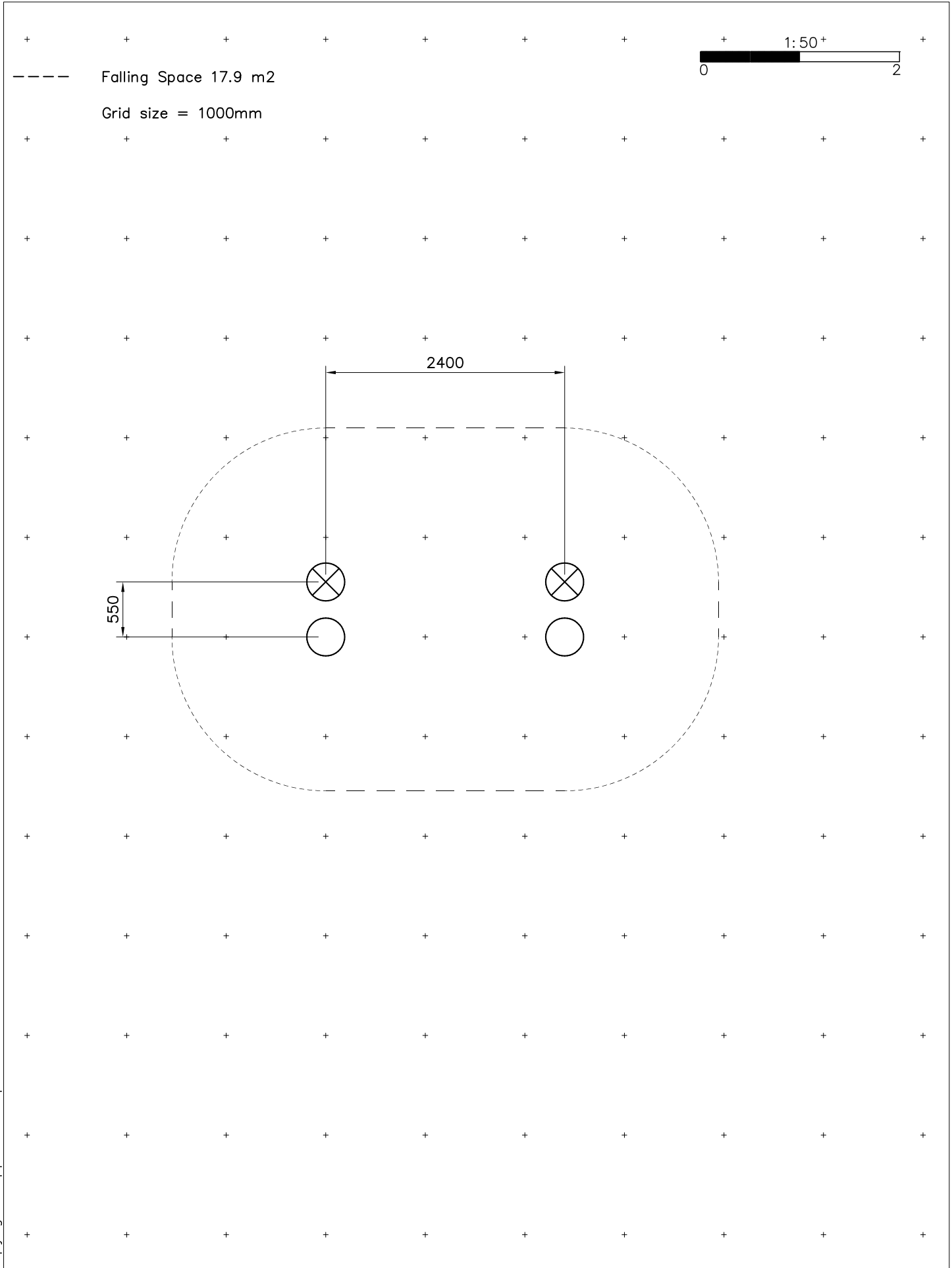

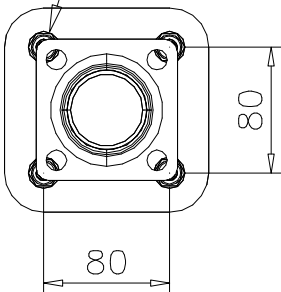
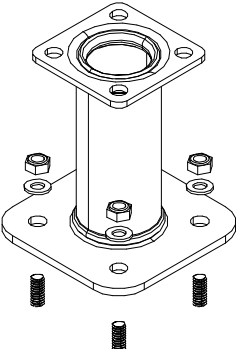
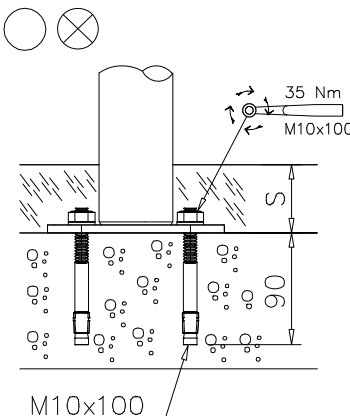
<p>Pre-drill hole $\varnothing 10 \downarrow 90$ (x4)</p>  <p>80</p> <p>80</p>		 <p>35 Nm</p> <p>M10x100</p> <p>90</p> <p>M10x100</p>

----- Falling Space 43.9 m²

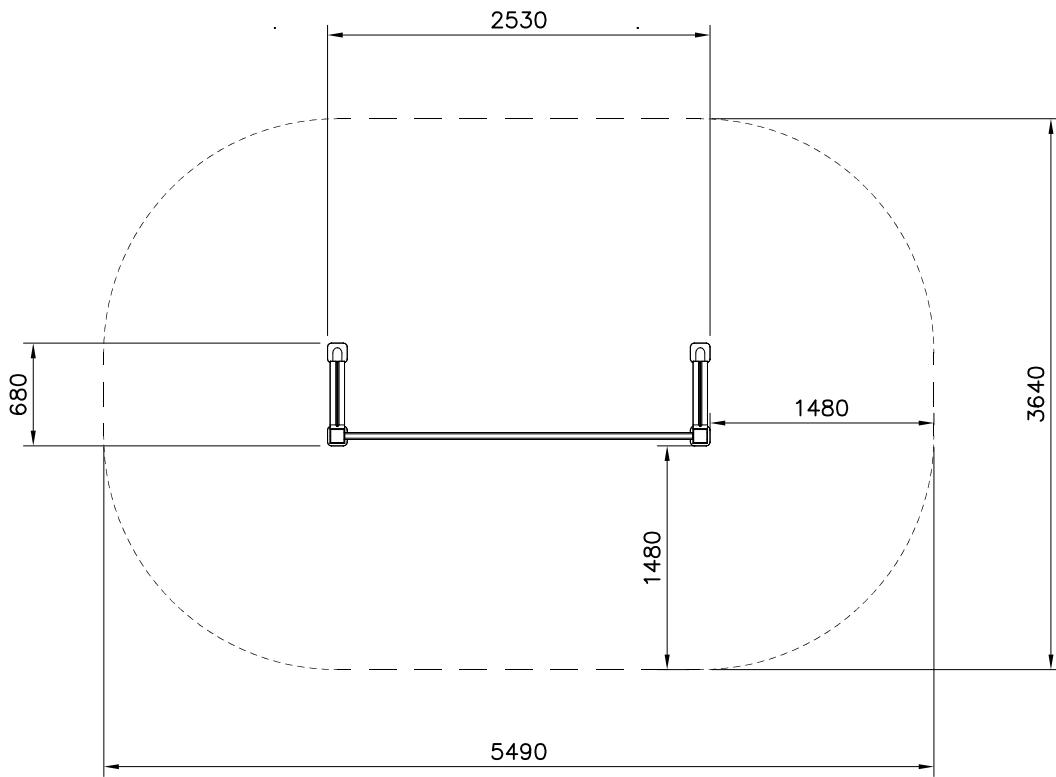
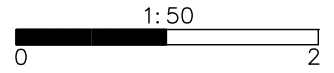

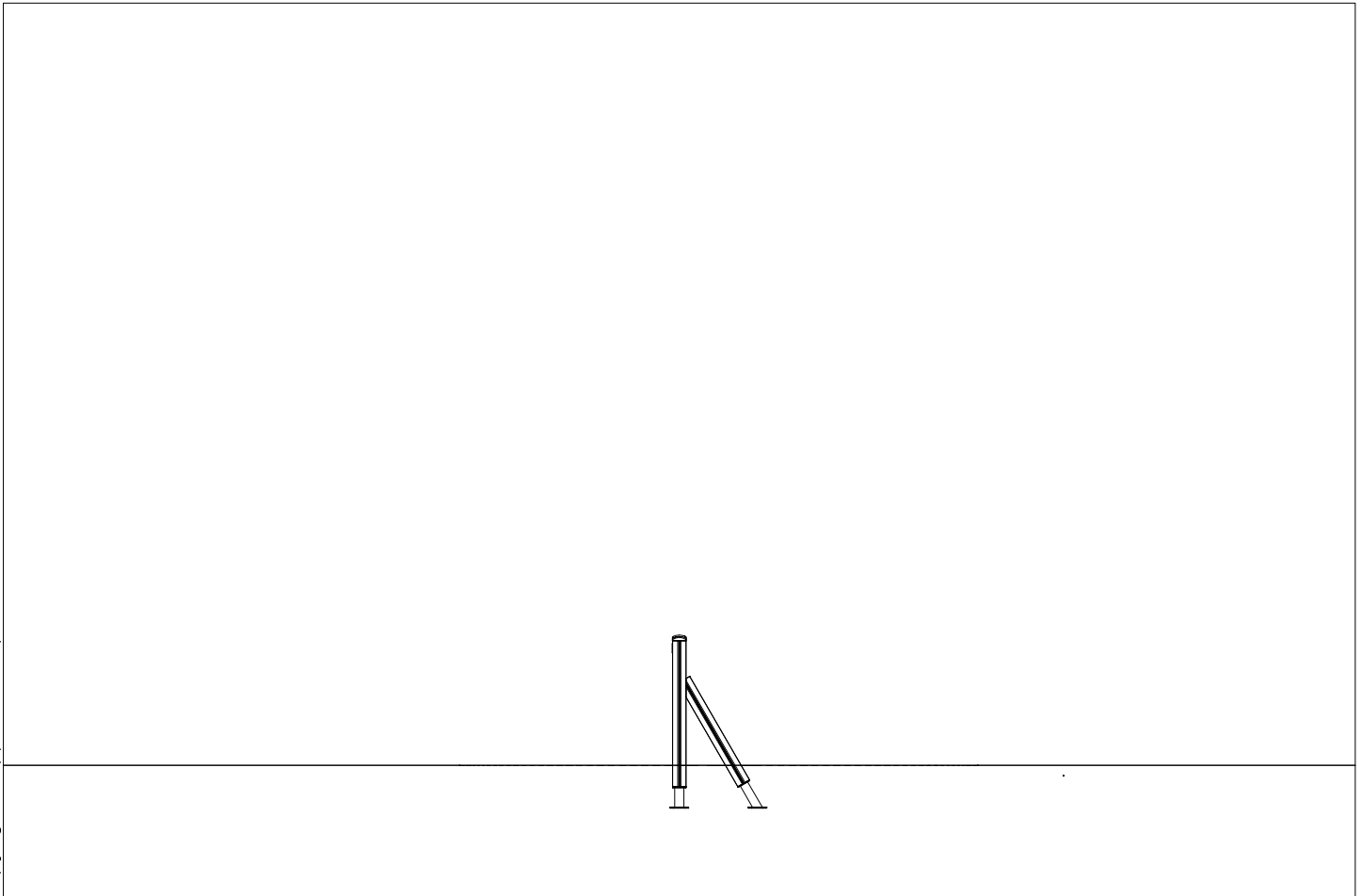
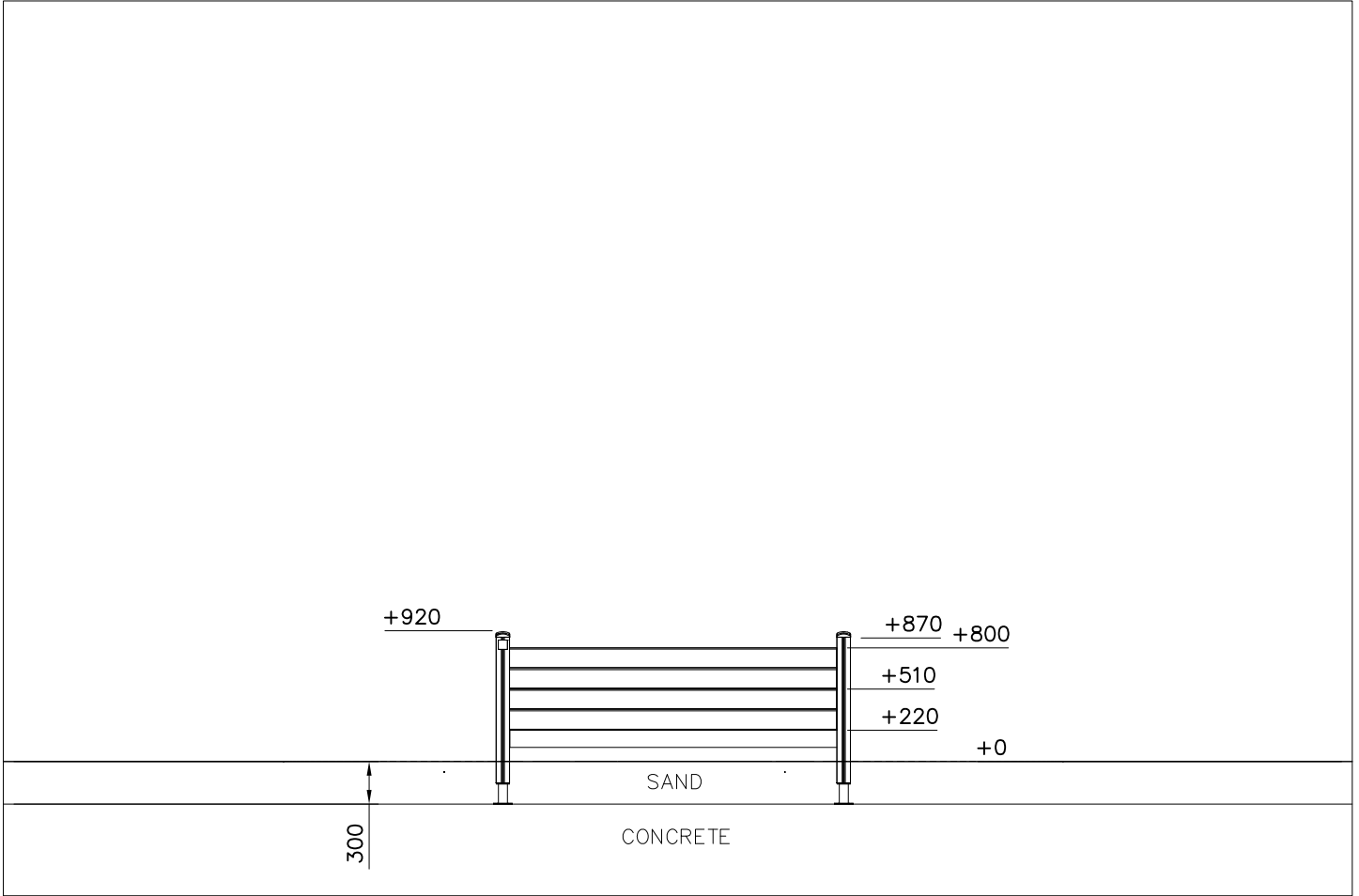

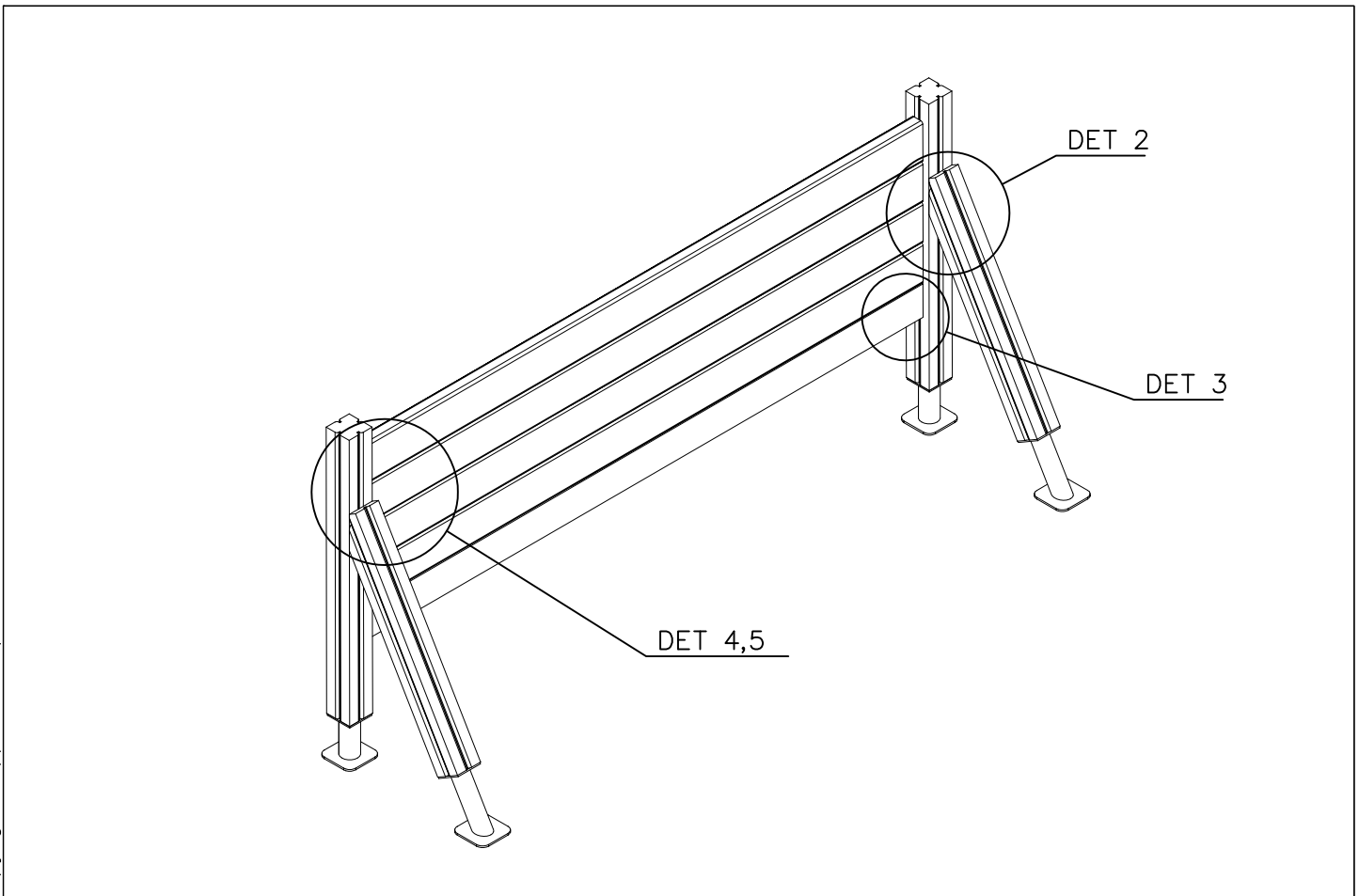
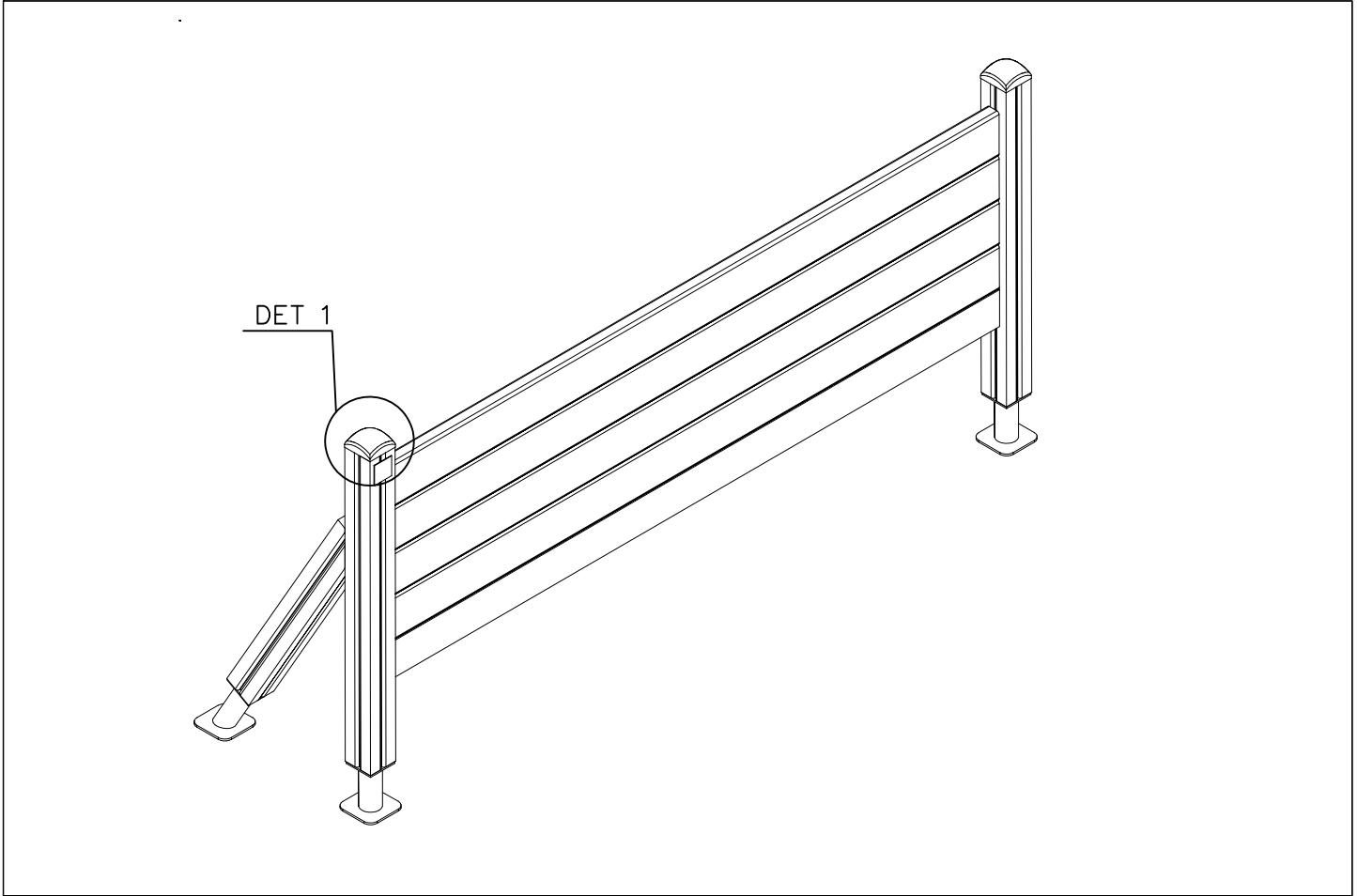

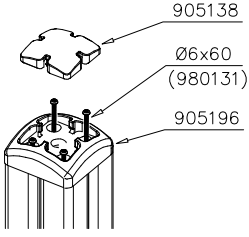
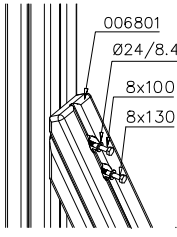
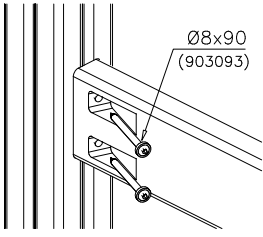
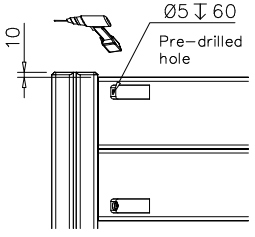
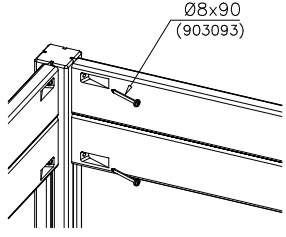
<p>DET 1</p>  <p>905138 Ø6x60 (980131) 905196</p>	<p>DET 2</p>  <p>006801 Ø24/8.4 8x100 8x130</p>	<p>DET 3</p>  <p>Ø8x90 (903093)</p>	<p>DET 4</p>  <p>Ø5 ∇ 60 Pre-drilled hole 10</p>
<p>DET 5</p>  <p>Ø8x90 (903093)</p>			

